

KOMATSU®

GD535-5

GD
535

HORSEPOWER

Gross: 115 kW 154 HP / 2000 min⁻¹

Net: 108 kW 145 HP / 2000 min⁻¹

OPERATING WEIGHT

13680 kg (Cab)

BLADE LENGTH

3.71 m



Photos may include optional equipment.

WALK-AROUND





PRODUCTIVITY

- ▮ High Productivity & Low Fuel Consumption
- ▮ Lock-up Torque Converter Transmission
- ▮ Long Wheelbase & Short Turning Radius

ECOLOGY & ECONOMY

- ▮ Komatsu Technology
- ▮ High Performance and Low Emission Engine
- ▮ Engine Power Mode Selection System

COMFORT

- ▮ Excellent Visibility
- ▮ ROPS/FOPS Cab/Canopy (ISO 3471/ISO 3449)

MAINTENANCE

- ▮ Easy Maintenance Design
- ▮ Maintenance Information Display

RELIABILITY

- ▮ Components that Prevent Machine Failure and Improve Machine Reliability

ATTACHMENTS

- ▮ Komatsu genuine attachment tools

* Information and Communication Technology

ICT* & KOMTRAX

- ▮ High Resolution 3.5" Liquid Crystal Display (LCD) Color Monitor
- ▮ KOMTRAX

GD535-5

HORSEPOWER	Gross: 115 kW 154 HP / 2000 min ⁻¹
	Net: 108 kW 145 HP / 2000 min ⁻¹
OPERATING WEIGHT	13680 kg (Cab)
BLADE LENGTH	3.71 m

PRODUCTIVITY

High Productivity & Low Fuel Consumption

Improvements in transmission and axles raises efficiency, and the sophisticated electronic engine and transmission control offers optimized output - all combined - realizing 15% better production and 14% better fuel consumption in the field compared with the GD511A-1.

Production

15% up (P mode)

Fuel consumption

14% reduction (E mode)

(Compared with GD511A-1)

*Fuel consumption varies depending on the job conditions.



Lock-up Torque Converter Transmission

The lock-up torque converter transmission is specially designed for Komatsu graders. This provides both efficiency of direct shifting and operability of automatic shifting.

1) Transmission Mode Selection

• Auto mode

Drive with Torque Converter in all shift position. This mode provides high controllability and torque multiplication. Additionally Lock-up will work in F5-F8 and R3-R4 position. For example shifting F8 position serves automatic shifting through F4-F8 in response to machine speed.

• Manual mode

Works like a same way as conventional power shift, by engaging lock-up clutch with all gears. This mode maximize efficiency of direct shifting. In reverse travelling, works same way as Auto mode, serves less operation frequency.



2) Anti Stall

Prevents engine stalling while Lock-up, never needs to restart the engine and shift the gear.

3) Electronic Over-speed Protection

Restricts downshifting until reducing the travel speed to the safe range of shift changing.

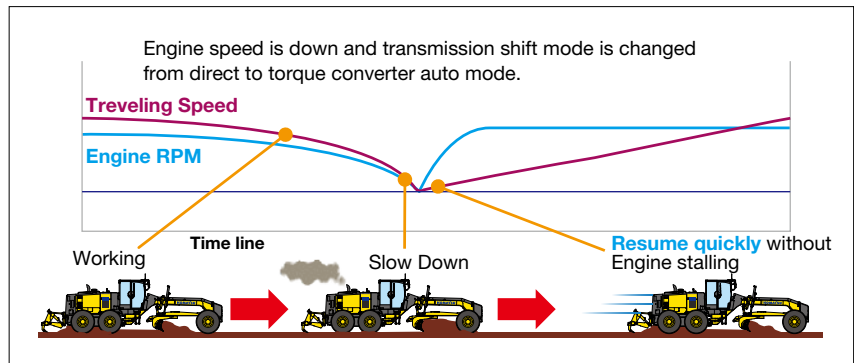

Long Wheelbase & Short Turning Radius

The long wheelbase enables high leveling performance and easier to set the blade position. Long wheelbase also contributes to expanding blade reach in combination with large articulation angle. Additionally the minimum turning radius still short with wide steering angle, serves high maneuverability.



ECOLOGY & ECONOMY

Komatsu Technology

Komatsu uniquely develops all major components including total control system, like engines, electronics, and hydraulic components. With this “Komatsu Technology” and continuous customer feedback, Komatsu has been achieving great advancements in technology. This resulted in new generation of high performance and environmentally friendly products.

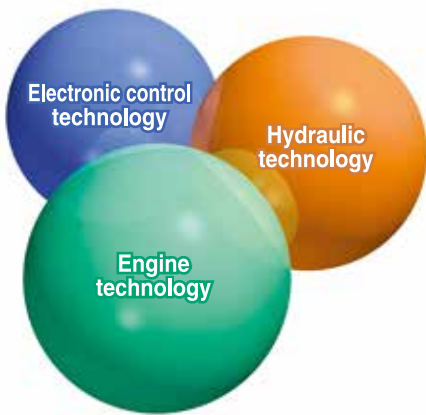

High Performance and Low Emission Engine

Komatsu SAA6D107E-1, turbocharged and air-to-air aftercooled engine, realizes high productivity and low fuel consumption. Common rail injection system provides precise throttle control and thus it delivers higher work speeds with high horsepower. Two P and E modes optimize engine outputs and help to reduce fuel consumption.





Engine Power Mode Selection System

The system allows the operator to select from the two modes, <P mode> or <E mode>, according to the working conditions. The selector switch which is on the console is easy to access.

• P mode

Maximize production by taking full advantage of engine output. Appropriate for job sites which emphasize productivity.

• E mode

Suited for carrying out lighter work economically. This feature provides the sufficient power, better fuel consumption, and prevents tire slipping to extend tire life.

Electric Throttle Control

Throttle is electronically controlled and the operator can set the optimal engine RPM at hand.



1 RPM set switch

2 Power mode selector switch

COMFORT

Excellent Visibility

Excellent visibility of hexagonal floor and rear layout side pillar boosts operator's confidence and productivity in all grader applications. Well-positioned blade linkage provides an unobstructed view of the moldboard and front tires.



Rear view



ROPS/FOPS Structure

Low profile cab and canopy are designed to ensure ROPS/FOPS (ISO 3471/ISO 3449) certification.

Cab



Adjustable Control Console

The control console moves back and forth and the operator easily gets in and out of the operator compartment. The steering wheel also tilts to suit the operator's preference.



Lunch Box Tray and Cup Holder

The tray and cup holder for personal items, placed at the left side of the operator's seat for Cab. Large tray for Canopy.



Other Cab Accessories

- **Air Conditioner (A/C)**

Increase air flow rate by refurbishing the shape of air outlets.



- **12V Outlet**



- **Ashtray**



- **Mobile Phone Tray**



- **Suspension Seat (Optional)**

Adopt high-rigidity suspension seat to enhance vibration absorption.



MAINTENANCE

Easy Maintenance Design

Ground refueling

Easily refueling from the ground eliminates the need for climbing on and down from the tandem.



Large fuel filter and fuel pre-filter with water separator

Provides the large filter with enhanced filtering performance, surely removes water and dirt in fuel to prevent fuel system troubles.



Fuel pre-filter

Service access platform

The punched metal foot plates on the tandem and grab rails ensure safety maintenance and inspection.



Easy access to service points

Wide-open engine hood doors improve accessibility to service points. All major service points are accessible from the ground level.



Maintenance Information Display

“Maintenance time caution lamp” display

When the remaining time before maintenance becomes less than 30 hours*, the maintenance time monitor appears. Pressing the key switches on the monitor to change to the maintenance screen.

* The setting can be changed within the range between 10 and 200 hours.



RELIABILITY

Components that Prevent Machine Failure and Improve Machine Reliability

Slip clutch circle drive

Protects the work equipment from shock load when the blade hits an obstruction.



Hydraulically controlled wet multiple-disc brake

This brake system is completely sealed and adjustment-free. The large braking surface provides dependable braking capability and extends life before an overhaul.



Sealed connectors

Wiring harnesses and controller are connected by sealed connectors providing high reliability, water resistance, and dust resistance.

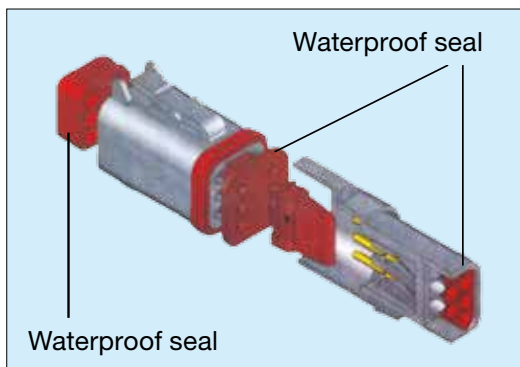

Double seal cylinder (Blade side shift cylinder)

A double-seal design is used for the blade side shift cylinder, which is installed near the ground and possibly gets dirt.

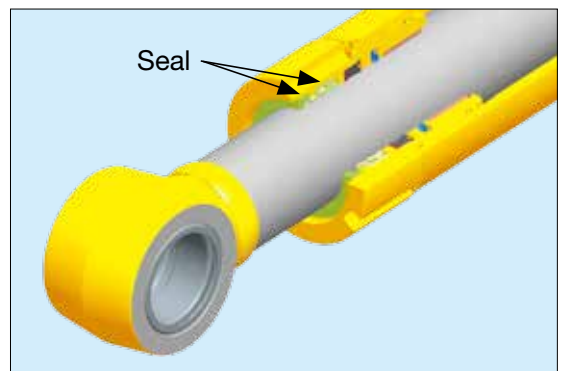

Battery Location

The battery bay is elevated from the ground and prevents intrusion of dusts into the battery and power supply circuit.



ATTACHMENTS

Komatsu Genuine Attachment Tools

Moldboard

Includes replaceable metal wear inserts, cutting edge and end bits. Cutting edge and end bits are hardened.



Scarifier and Ripper

Digs up hard material cannot be removed by the blade. This scarifier can accommodate up to 9 teeth. The ripper also can accommodate up to 5 shanks.



KOMATSU NEW ENGINE TECHNOLOGIES



High Resolution 3.5" LCD Color Monitor

The high resolution 3.5-inch color LCD monitor improves its visibility. The function switches are simple and easy to operate. The operator easily accesses various user menus like maintenance information, and operation record, also adjusts the machine settings.

Indicator, switches

- | | |
|---|--------------------------------------|
| 1 LCD unit | 8 Speedometer |
| 2 Warning lamp | 9 Tachometer |
| 3 Pilot lamp | 10 Articulation indicator |
| 4 Pilot display | 11 Shift indicator |
| 5 Engine coolant temperature gauge | 12 Fuel gauge |
| 6 Torque converter oil temperature gauge | 13 Gear shift lever position display |
| 7 Service meter / Odometer / Clock / Fuel consumption gauge display | 14 Function switches |

Visual user menu

The menus are grouped according to each function with easily understandable icons which enable the operator to reach the information intuitively.



- 1 ECO Guidance
- 2 Maintenance
- 3 Monitor settings
- 4 Message Display

Operation record and fuel consumption history

The ECO guidance menu enables the operator to check the operation record and fuel consumption history by pushing the button. The records can be used to reduce the overall fuel consumption.

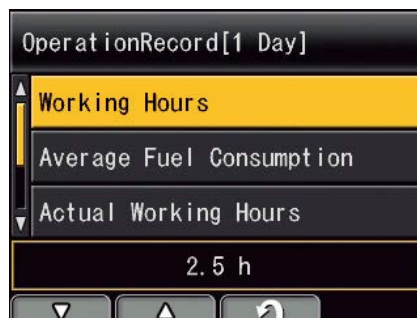

Operation record



Fuel consumption record

Maintenance history

The monitor system can record the maintenance history such as changing the engine oil.

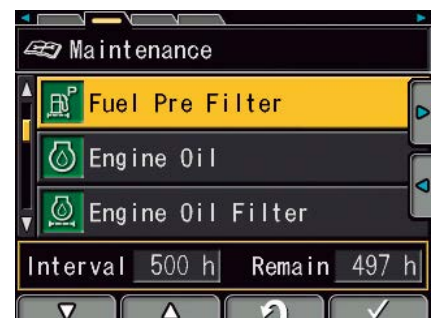

KOMTRAX

The Komatsu remote monitoring and management technology provides insightful data about your equipment and fleet in user-friendly format.

Energy Saving Operation Report

KOMTRAX delivers the energy-saving operation report based on the operating information such as fuel consumption, load summary and idling time, which helps you efficiently run a business.



This report image is an example of hydraulic excavator

Equipment Management Support

Through the web application, a variety of search parameters are available to quickly find information about specific machines based on key factors. Moreover, KOMTRAX finds out machines with problems from your fleet and shows you through an optimal interface.

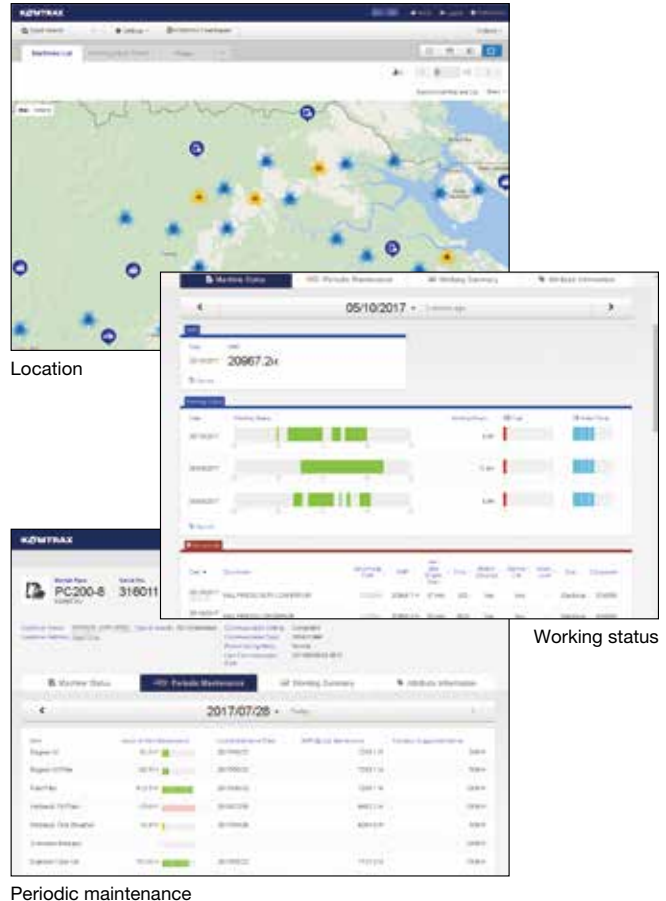

The report contents and data depend on the machine model.

Optimal Strategy for Efficient Work

The detailed information that KOMTRAX puts at your fingertips helps you manage your fleet conveniently on the web anytime, anywhere. It gives you the power to make better daily and long-term strategic decisions.



KOMATSU TOTAL SUPPORT



Komatsu Total Support

To keep your machine available and minimize operation cost when you need it, Komatsu Distributor is ready to provide a variety of supports before and after procuring the machine.

Fleet recommendation

Komatsu Distributor can study the customer's job site and provide the most optimum fleet recommendation with detailed information to meet all of your application needs when you are considering to buy new machines or replace the existing ones from Komatsu.

Product support

Komatsu Distributor gives the proactive support and secures the quality of the machinery that will be delivered.

Parts availability

Komatsu Distributor is available for emergency inquiry by the customers for genuine, quality guaranteed Komatsu parts.

Technical support

Komatsu product support service (Technical support) is designed to help customer. Komatsu Distributor offers a variety of effective services to show how much Komatsu is dedicated to the maintenance and support of Komatsu machine.

- Preventive Maintenance (PM) clinic
- Oil & Wear analysis program

Repair & maintenance service

Komatsu Distributor offers quality repair and maintenance service to the customer, utilizing and promoting Komatsu developed programs.

Komatsu Reman (Remanufactured) components

Komatsu Reman products are the result of the implementation of the Komatsu global policy which establishes and agrees to reduce the owning, operating and total Life Cycle Costs (LCC) to Komatsu's customer through high quality, prompt delivery and competitively priced in own remanufactured products (QDC).



SPECIFICATIONS



ENGINE

ModelKOMATSU SAA6D107E-1
 Type.....Water-cooled, 4-cycle, direct injection
 AspirationTurbocharged and air to air aftercooled
 Number of cylinders6
 Bore.....107 mm
 Stroke124 mm
 Piston displacement6.69 L
 Horsepower (Manual mode)
 P-mode
 SAE J 1995Gross 115 kW 154 HP/2000 min⁻¹
 ISO 9249/SAE J 1349Net 108 kW 145 HP/2000 min⁻¹
 E-mode
 SAE J 1995Gross 107 kW 143 HP/2000 min⁻¹
 ISO 9249/SAE J 1349Net 101 kW 135 HP/2000 min⁻¹
 Maximum torque.....658 Nm 67.1 kgf·m/1450 min⁻¹
 Torque rise24 %
 Fan speedMax 1628 min⁻¹
 Air cleaner2-stage, dry-type
 U.S. EPA Tier 3 and EU Stage 3A emissions equivalent.



TRANSMISSION AND TORQUE CONVERTER

Full power shift transmission with torque converter and lock-up.
 Speeds (at rated engine speed)

Gear	Forward	Reverse
1st	4.3 km/h	4.8 km/h
2nd	6.1 km/h	9.4 km/h
3rd	8.2 km/h	18.4 km/h
4th	11.6 km/h	35.2 km/h
5th	16.2 km/h	-
6th	22.7 km/h	-
7th	31.1 km/h	-
8th	43.4 km/h	-

Maximum travel speed at engine high idle is 47.5 km/h.

Travel speeds calculated with 14.00-24-12PR tires.



TANDEM DRIVE

Oscillating welded box section.....490 mm x 203 mm
 Side wall thickness: Inner22 mm
 Outer.....19 mm
 Wheel axle spacing1525 mm
 Tandem oscillation11 ° forward, 13 ° reverse



FRONT AXLE

Type.....Solid bar construction welded steel sections
 Ground clearance at pivot.....600 mm
 Wheel lean angle, right or left16 °
 Oscillation, total.....32 °



REAR AXLE

Alloy steel, heat treated, full floating axle.
 Lock/unlock differential optional.



STEERING

Hydraulic power steering providing stopped engine steering meeting ISO 5010.
 Minimum turning radius7.0 m
 Maximum steering range, right or left.....49 °
 Articulation25 °



BRAKES

Service brakeFoot operated, wet multiple-disc brakes, hydraulically actuated on four tandem wheels.
 Parking brakeManually actuated, spring applied, hydraulically released caliper disc type.



FRAME

Front Frame Structure
 Height300 mm
 Width280 mm
 Side22 mm
 Upper, Lower.....28 mm



DRAWBAR

A-shaped, welded construction for maximum strength with a replaceable drawbar ball.
 Drawbar frame.....220 mm x 16 mm



CIRCLE

Single piece rolled ring forging. Four circle support shoes with replaceable wear plates.
 Diameter (outside).....1410 mm
 Circle reversing control hydraulic rotation360 °



MOLDBOARD

Hydraulic power shift fabricated from steel. Includes replaceable metal wear inserts, cutting edge and end bits.
Cutting edge and end bits are hardened.
Dimensions 3710 mm x 645 mm x 16 mm
Arc radius 329 mm
Cutting edge 152 mm x 16 mm
Replaceable/Reversible side edges . . . 229 mm x 496 mm x 13 mm
Blade pull
Base GVW 7945 kgf
With scarifier GVW 8015 kgf
With ripper GVW 8510 kgf
Blade down pressure
Base GVW 5835 kgf
With scarifier GVW 6575 kgf
With ripper GVW 7175 kgf



BLADE RANGE

Moldboard side shift:
Right 775 mm
Left 775 mm
Maximum shoulder reach outside rear tires (frame straight)
Right 1990 mm
Left 1920 mm
Maximum lift above ground 500 mm
Maximum cutting depth 545 mm
Maximum blade angle, right or left 90 °
Blade tip angle 40 ° forward, 3 ° backward



HYDRAULICS

Hydraulic pumps:
Tandem gear pump for work equipment steering control Capacity 72 L/min + 36 L/min
Relief valve setting:
Work equipment 19.1 MPa 195 kgf/cm²
Steering 17.7 MPa 180 kgf/cm²



INSTRUMENT

Electric monitoring system with diagnostics:
Gauges:
Standard articulation, engine coolant temperature, fuel level, speedometer, transmission shift indicator, engine tachometer, torque converter oil temperature
Warning lights/Indicator:
Standard battery charge, brake oil pressure, inching temperature, directional indicator, engine oil pressure, hydraulic oil temperature, heater signal, lift arm lock, parking brake, torque converter oil temperature, eco, P mode, rpm set, high beam, working lights



CAPACITIES (REFILLING)

Fuel tank 271 L
Cooling system 24 L
Crank case 23.1 L
Transmission 45 L
Final drive 13 L
Tandem housing (each) 51 L
Hydraulic system 51.5 L
Circle reverse housing 4.1 L



OPERATING WEIGHT (APPROXIMATE)

Includes lubricants, coolant, full fuel tank, ROPS/FOPS cab/canopy, 14.00-24 tires and single-piece rims:
Total (Cab) 13680 kg
(Canopy) 13310 kg
On rear wheels (Cab) 9985 kg
(Canopy) 9670 kg
On front wheels (Cab) 3695 kg
(Canopy) 3640 kg
With front mounted scarifier:
Total (Cab) 14260 kg
(Canopy) 13865 kg
On rear wheels (Cab) 10100 kg
(Canopy) 9755 kg
On front wheels (Cab) 4160 kg
(Canopy) 4110 kg
With rear mounted ripper and front push plate:
Total (Cab) 15150 kg
(Canopy) 14785 kg
On rear wheels (Cab) 10640 kg
(Canopy) 10325 kg
On front wheels (Cab) 4510 kg
(Canopy) 4460 kg



SCARIFIER (OPTIONAL)

Middle, V-type
Working width 1065 mm
Scarifying depth, maximum 200 mm
Scarifier shank holders 9
Scarifier shank holders spacing 130 mm



RIPPER (OPTIONAL)

Ripping depth, maximum 273 mm
Ripper shank holders 5
3 shanks are standard additional 2 shanks as a optional
Ripper shank holder spacing 459 mm
Penetration force 7610 kgf
Pry out force 3225 kgf
Machine length increase, beam raised 1008 mm



DIMENSIONS

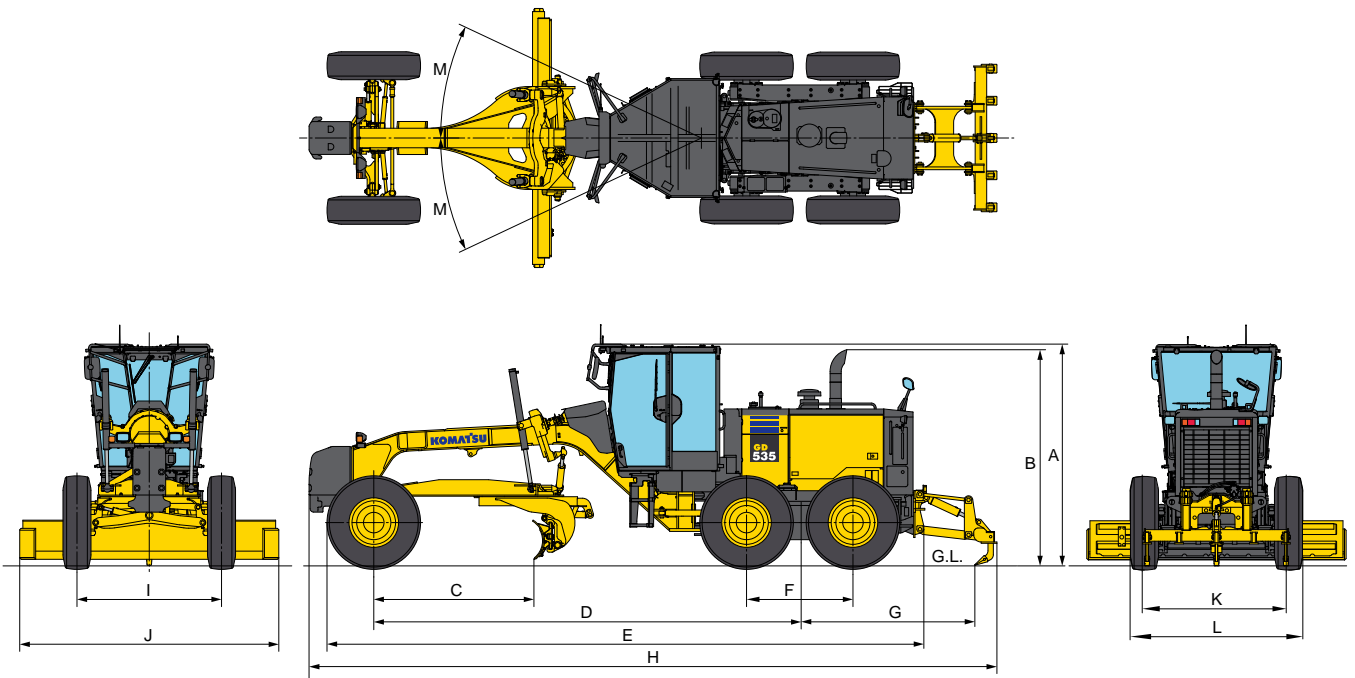

A	Height : Cab	3250 mm *2
B	Height : Muffler (Cab)	2840 mm *2
	Height : Muffler (Canopy)	3075 mm *2
C	Cutting edge to center of front axle	2265 mm
D	Wheelbase to center of tandem	6100 mm
E	Front tire to rear bumper (Rear hook)	8565 mm
F	Tandem wheelbase	1525 mm
G *1	Center of tandem to back of ripper	2510 mm
H *1	Overall length	9880 mm
I	Tread (front)	2070 mm
J	Width of standard moldboard	3710 mm
K	Tread (rear)	2060 mm
L	Width over tires	2455 mm *2
M	Articulation, left or right	25°

*1: Optional

*2: When equipped with 14.00-24 tires



WHEELS, FRONT AND REAR

Tire	Rim size	Wheel group
13.00-24	9"	Single-piece
14.00-24	9"	Single-piece
14.00-24	10"	Multi-piece
14.00-R24	10"	Multi-piece



STANDARD EQUIPMENT

Engine and Related Items

- Air intake extension
- Double element air cleaner and dust indicator
- Engine: Komatsu SAA6D107E-1, U.S. EPA Tier 3 and EU Stage 3A emissions equivalent, turbocharged and air-to-air aftercooled, 135HP/145HP net horsepower
- Fuel pre-filter

Electrical Systems

- Alarm, back-up
- Alternator, 24V/35A
- Battery, 2 x 12V/112Ah
- Horn, electric
- Indicators: parking brake, turn signal, lighting, high beam, brake oil pressure
- KOMTRAX, 3G or Orbcomm
- Lights: back-up, stop, tail, directional, headlights (2 halogen type, front bar mounted)
- Multi color monitor

Operator Environment

- Console, adjustable with instrument panel monitoring system
- Floor mat
- Mirrors: right and left exterior mirrors
- Seat, vinyl with seat belt

Power Train

- Axle, rear full floating, planetary type
- Brake, parking, spring applied, hydraulic release, cariper disc type
- Dual mode transmission (F8-R4) power shift, direct drive and torque converter with auto shift, engine stall prevention function
- Service brakes, fully hydraulic wet disc

Cab Accessories

- Air conditioner
- Cup holder
- 12V outlet
- Room mirror
- Wiper and washer

Work Equipment and Hydraulics

- 9 section hydraulic control valve
- Circle, drawbar mounted, 360° rotation hydraulic blade lift and circle side sift
- Circle slip clutch
- Moldboard: 3710 mm x 645 mm x 16 mm with replaceable end bits, through-hardened cutting edges 152 mm x 16 mm, hydraulic blade side shift
- Steering, full hydraulic with tilt steering wheel plus leaning front wheels and frame articulation w/anti-drift check valves

Other Standard Equipment

- Fuel tank, ground level access
- Painting, Komatsu standard color scheme
- Steps and handrails, rear, right and left side
- Vandalism protection includes lockable access to fuel tank, battery cover and engine side covers
- Work lamps: front (2), rear (1)



OPTIONAL EQUIPMENT

- Adjustable seat, fabric (Cab)
- Alternator, 24V/60A
- AM/FM radio (Cab)
- Battery disconnect switch
- Cab mount floodlight (Cab)
- Differential, lock/unlock
- Fire extinguisher
- General toolkit
- Hydraulic blade tip
- Large capacity batteries, 2 x 12 V/120 Ah
- Licence-plate light
- Pre-cleaner
- Push plate

- Rear view camera (Cab, hydraulic fan)
- Ripper
- Scarifier
- Steering cylinder guard
- Tool box with lock
- Transmission under guard
- Warning light, amber beacon

Hydraulic cooling fan

- Changes in horsepower
 - P-mode
 - SAE J 1995
 - Gross 114.5 kW 153 HP/2000 min⁻¹
 - ISO 9249/SAE J1349
 - Net 113 kW 151 HP/2000 min⁻¹
 - E-mode
 - SAE J 1995
 - Gross 107 kW 143 HP/2000 min⁻¹
 - ISO 9249/SAE J1349
 - Net 106 kW 142 HP/2000 min⁻¹

Standard and optional equipment may vary. Please consult your Komatsu distributor for detail.

<https://home.komatsu/en/>

Printed in Japan 201904 IP.PC1