

KOMATSU®

D375A-6

HORSEPOWER

Gross: 474 kW 636 HP / 1800 min⁻¹

Net: 455 kW 610 HP / 1800 min⁻¹

OPERATING WEIGHT

71640 kg 157,940 lb

ecot3

D
375A

CRAWLER DOZER



Photo may include optional equipment.

WALK-AROUND

SAA6D170E-5 turbocharged after-cooled diesel engine provides an output of **474 kW** 636 HP with excellent productivity. This machine is U.S. EPA Tier 3 and EU stage 3A emissions certified.
See page 6.

Preventative maintenance

- Centralized Service Station
 - Enclosed Hydraulic Piping
 - Modular Power Train Design
 - Oil Pressure Checking Ports
- See page 9.

Automatic transmission with lockup torque converter increases speed and power to improve fuel consumption and productivity.
See page 6.

Large blade capacities:
18.5 m³ 24.2 yd³ (Semi-U dozer)
and **22.0 m³** 28.8 yd³ (U dozer)

Simple hull frame
and monocoque track frame with pivot shaft for greater reliability.

The **Dual tilt dozer** (optional) increases productivity while reducing operator effort.
See page 6.

Track link design reduces maintenance cost by making turning pins easier, with improved pin reuse.
See page 9.

Komatsu-integrated design for the best value, reliability, and versatility. Hydraulics, power train, frame, and all other major components are engineered by Komatsu. You get a machine whose components are designed to work together for higher production, greater reliability, and more versatility.

Hydraulic drive radiator cooling fan controlled automatically, reduces fuel consumption and operating noise levels, and the radiator can be easily cleaned by reversible fan.
See page 6.



Low-drive, long-track, eight roller undercarriage provides outstanding grading ability and stability.

Track shoe slip control system (optional) reduces operator fatigue.
See page 7.

Hexagonal designed cab includes:

- Spacious interior
- Comfortable ride with cab damper mounting and Komatsu Bogie (K-bogie) undercarriage
- Excellent visibility
- High capacity air conditioning system (optional)
- Palm Command Control System (PCCS) lever
- Pressurized cab (optional)
- Adjustable left armrest
- Travel control console integrated with operator seat
- New comfortable air-suspension seat (optional)

See page 8.

Large Liquid Crystal Display (LCD) monitor

- Easy-to-see and use 7" large multi-color monitor.
- Can be displayed in 10 languages for global support.

See page 8.

Electronic Controlled Modulation Valve

controlled steering clutch/brake system facilitates smooth and shockless steering operation.

See page 5.

Palm Command Control System (PCCS)

- Electronic controlled PCCS travel control
- Hydraulic controlled PCCS blade/ripper control
- Fuel control dial
- Automatic/manual gearshift selectable mode
- Gearshift pattern preset function
- Electronic Controlled Modulation Valve controlled transmission

See page 4.

Rippers (optional):

- Variable giant
- Multi-shank

See page 7.



Photo may include optional equipment.

Komatsu Bogie (K-bogie) undercarriage system

high traction, component durability, and operator comfort.

See page 8.

Extra-low machine profile

provides excellent machine balance and low center of gravity.

HORSEPOWER
 Gross: 474 kW 636 HP / 1800 min⁻¹
 Net: 455 kW 610 HP / 1800 min⁻¹

OPERATING WEIGHT

71640 kg 157,940 lb

BLADE CAPACITY

Semi-U: 18.5 m³ 24.2 yd³

Full-U: 22.0 m³ 28.8 yd³

CONTROL FEATURES

Komatsu's ergonomically designed control system "Palm Command Control System (PCCS)" creates an operating environment with "complete operator control."

Human-Machine Interface

Palm command electronic controlled travel control joystick

Palm command travel joystick provides the operator with a relaxed posture and superb fine control without operator fatigue. Transmission gear shifting is simplified with thumb push buttons.

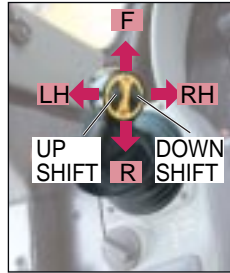

Fully adjustable suspension seat and travel control console

For improved rear visibility during return part of cycle, the operator can adjust the seat 15° to the right. The transmission and steering controls move with the seat for best operator comfort. The travel control console also has adjustments fore and aft and for height. With an independently adjustable armrest, each D375A operator can adjust control positions to his individual preference, providing optimum operational posture for all operators.

Facing front



When turned 15°



Fuel control dial

Engine speed is controlled by electric signals, providing ease of operation eliminating maintenance of linkage and joints.

Palm command Pressure Proportional control (PPC) controlled blade control joystick

Blade control joystick uses the PPC valve and the same palm command type joystick as travel control joystick. PPC control, combined with the highly reliable Komatsu hydraulic system, provides superb fine control. (Dual tilt and pitch operation are activated by depressing switch with a thumb. This is available with optional dual tilt dozer.)

Blade and ripper control joysticks



Height adjustable blade control armrest

Blade control armrest is height adjustable without any tools in three stages, providing the operator with firm arm support and ideal armrest positioning.

Position adjustable ripper control lever

Ripper control lever is position adjustable, providing optimum operation posture for all operators during ripping operations facing front or watching ripper point.

Power Train Electronic Control System

Smooth operation

D375A-6 uses a newly designed power train electronic control system. The controller registers the amount of operator control (movements of lever and operation of switches) and machine condition signals from each sensor, and calculates to accurately control torque converter, transmission, steering clutches and brakes for optimized machine operation. The ease of operation and productivity of the new D375A-6 is greatly improved by numerous new functions.

Electronic Controlled Modulation Valve controlled transmission

Controller automatically adjusts each clutch engagement depending on travel conditions such as gear speed, revolution and shifting pattern. This provides shockless smooth clutch engagement, improved component reliability, expansion of component life and operator riding comfort.

Electronic Controlled Modulation Valve controlled steering clutches/brakes

Sensors monitor machine operating conditions, and the controller activates Electronic Controlled Modulation Valve electronically to control steering clutches and brakes depending on type of job, such as size of load during dozing, incline angle of slope or load, providing smooth and ease of operation by reducing counter-steering on downhill travel, etc.

Effect of Electronic Controlled Modulation Valve steering clutches/brake control

When dozing and turning, Electronic Controlled Modulation Valve automatically controls stroke ratio of steering clutches and brakes depending on degree of load, enabling smooth dozing and turning.

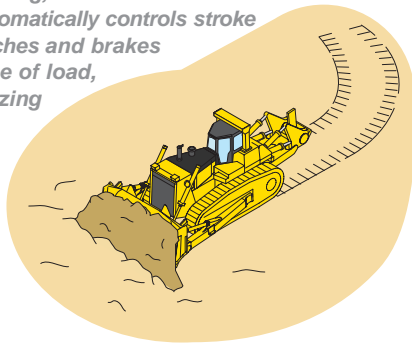

When dozing downhill, Electronic Controlled Modulation Valve automatically controls steering clutches and brakes depending on incline of machine or degree of load, reducing counter-steering and producing smooth dozing operation.

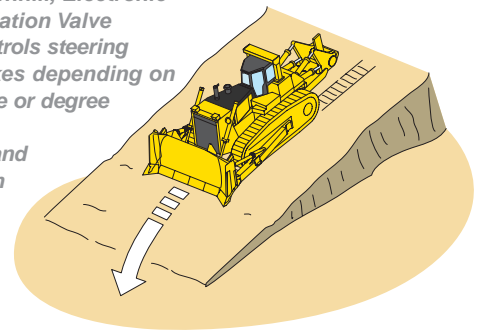

Preset travel speed selection function

When the gearshift pattern is set to either <F1-R2>, <F2-R2> or <F2-R3L> in automatic gearshift mode, the gear is automatically shifted, reducing round trip repetition work time and operator's efforts.

	Automatic gearshift mode	Manual gearshift mode	Shoe slip control mode (optional)
	F1-R1 MODE Press DOWN switch ↑ Press UP switch ↓	F1-R1 MODE Press DOWN switch ↑ Press UP switch ↓	F1-R1 MODE Press DOWN switch ↑ Press UP switch ↓
	F1-R2 MODE Press DOWN switch ↑ Press UP switch ↓	F1-R2 MODE Press DOWN switch ↑ Press UP switch ↓	F1-R2 MODE Press DOWN switch ↑ Press UP switch ↓
	F2-R2 MODE Press DOWN switch ↑ Press UP switch ↓	F2-R2 MODE Press DOWN switch ↑ Press UP switch ↓	
	F2-R3L MODE Press DOWN switch ↑ Press UP switch ↓		

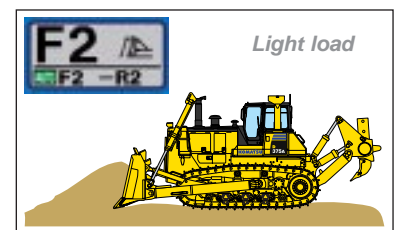
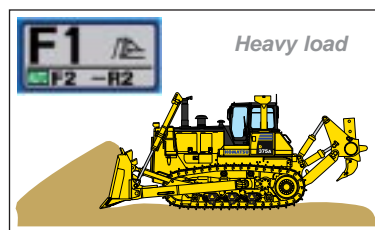

Auto downshift function

Controller monitors engine speed, travel gear and travel speed. When load is applied and machine travel speed is reduced, the transmission automatically downshifts to optimum gear speed to provide high fuel efficiency. This function provides comfortable operation without manual downshift and high productivity.

Actuated on heavy load or steep slope

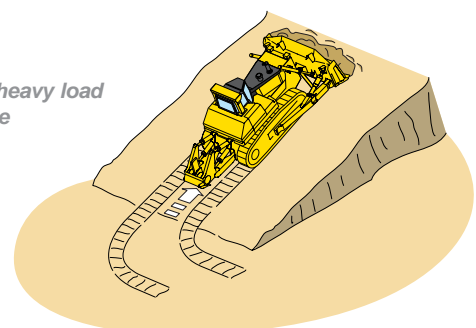

PRODUCTIVITY FEATURES



Engine

The Komatsu SAA6D170E-5 engine delivers **474 kW** 636 HP at 1800 rpm. The fuel-efficient Komatsu engine, together with the heavy machine weight, make the D375A-6 a superior crawler dozer in both ripping and dozing production. The engine is U.S. EPA Tier 3 and EU stage 3A emissions certified, and features direct fuel injection, turbocharger, air-to-air aftercooler and cooled EGR system to maximize fuel efficiency.

To minimize noise and vibration, the engine is mounted to the main frame with rubber cushions.

Hydraulic drive radiator cooling fan

Fan rotation is automatically controlled depending on coolant and hydraulic oil temperature, saving fuel consumption and providing great productivity with a quiet operating environment.

Automatic transmission with lockup torque converter

A sharp reduction in fuel consumption and greater power train efficiency is achieved by the new automatic gearshift transmission and lockup torque converter. The automatic gearshift transmission selects the optimal gear range depending on the working conditions and load placed on the machine. This means the machine is always operating at maximum efficiency. (Manual gearshift mode is selectable with a switch)

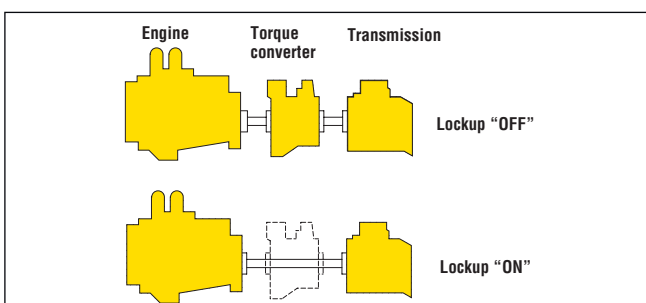

Komatsu Bogie (K-Bogie) undercarriage system

Komatsu Bogie (K-Bogie) undercarriage system combines prior advantages with additional features.

- Komatsu Bogie (K-Bogie) that oscillate with two fulcrums assure large amount of track roller vertical travel. Impact load to undercarriage components is minimized and durability of components is improved since track rollers are always in contact with track link.
- Track rollers follow track link movement to extend the undercarriage life.
- Excellent riding comfort is provided due to less vibration and shock when traveling over rough terrain.
- Komatsu Bogie (K-Bogie) with front and rear single bogies are utilized providing increased length of track on ground to improve machine stability and leveling performance.
- The oscillating idler and increased sprocket lead angle improve riding comfort when travelling over rough terrain.

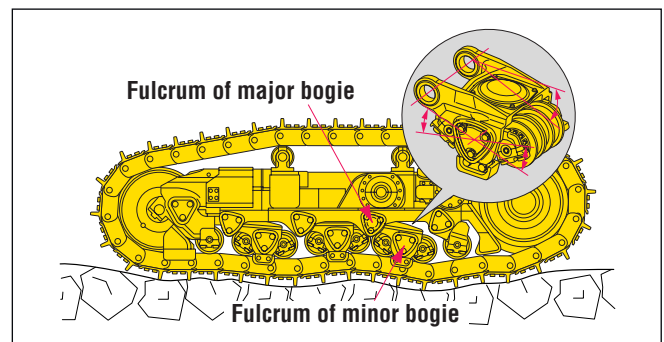

Large blade

Capacities of **18.5 m³** 24.2 yd³ (Semi-U dozer) and **22.0 m³** 28.8 yd³ (U dozer) yield outstanding production. High-tensile-strength steel comprising the front and sides of the blade increase durability. The shape of the blade features high load hauling efficiency. The end bit with improved cutting performance is standard equipment.

Dual tilt dozer (optional)

The dual tilt dozer increases productivity while reducing operator effort.

- Optimum blade cutting angle for all types of materials and grades can be selected on-the-go for increased load and production.
- Digging, hauling, and dumping are easy and smooth with less operator fatigue.
- Dozer tilt angle and tilt speed are twice that of a conventional single tilt system.

Rippers (optional)

- The variable giant ripper features a long sprocket center-to-ripper point distance, making ripping operation easy and effective while maintaining high penetration force.
- The variable giant ripper is a parallelogram single shank ripper ideal for ripping tough material. The ripping angle is variable, and the depth is adjustable in three stages by a hydraulically controlled pin puller.
- The multi-shank ripper is a hydraulically controlled parallelogram ripper with three shanks.



Automatic/manual gearshift selectable mode

Automatic or manual gearshift modes can be selected with ease to suit the work at hand by simply pressing the switch on the LCD monitor (The mode can be selected when the travel control joystick is at NEUTRAL.).

• **Automatic gearshift mode**

The mode for general dozing. When a load is applied, the gear automatically shifts down, and when the load is off, it automatically shifts up to a set maximum gear speed. This mode economizes both fuel and production where the torque converter lockup mechanism is actuated according to load, automatically selecting the optimum gear speed.

• **Manual gearshift mode**

The mode for dozing and ripping rough ground. When loaded, the gear automatically shifts down, but does not shift up when the load is off.

Working mode

This mode can be set to either “P mode” for the maximum power or “E mode” for energy saving operation. Combined with the automatic gearshift mode or manual gearshift mode, the working mode allows the operator to select the optimum machine operating condition for the work at hand. (The mode can be switched during operation.)

• **P Mode (Power mode)**

With P mode, the engine outputs its full power. Select this mode for the work requiring large production, heavy-load work, and uphill work.

• **E Mode (Economy mode)**

Select for energy saving operation with restricted engine power output. Select for the work on a ground where the machine may cause shoe slip and frequent decelerator pedal operation is required. Select for the work not requiring large power such as downhill dozing, leveling, and light-load work.

Working mode selector switch

P mode

E mode



Track shoe slip control mode (optional)

- Eliminates the need for the operator to constantly control engine power output with the decelerator pedal while ripping. Operator fatigue is substantially reduced.
- Maneuverability is improved because the operator is free to focus on the ripping application without having to monitor the track shoe slippage.
- Repair costs are significantly lowered and undercarriage life is prolonged with the reduction in track shoe slippage.
- The track shoe slip control system will contribute to lower fuel costs, because the engine output is automatically controlled to optimum levels for operation.

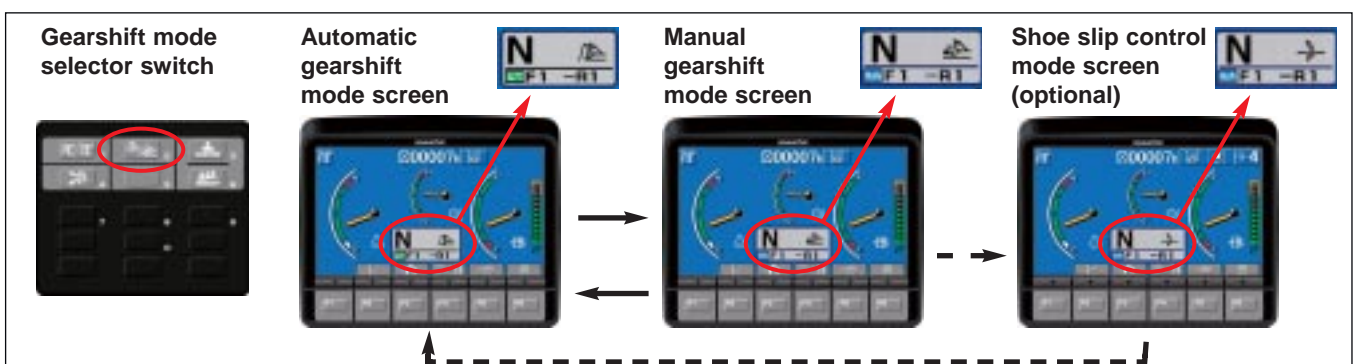

WORKING ENVIRONMENT



Photo may include optional equipment.



Hexagonal pressurized cab

- The cab's hexagonal design and large tinted glass windows provide excellent front, side and rear visibility.
- Air filters and a higher internal air pressure combine to prevent dust from entering the cab.

Fresh air intake from rear of engine hood

The air conditioner air intake port is now located at the rear of the engine hood where there is minimal dust. As a result, the air inside the cab is always clean. Cleaning interval of the filter is greatly extended, and use of a new structure filter element facilitates cleaning and replacement.

Large LCD color monitor

A large user-friendly color monitor enables safe, accurate and smooth work. Improved screen visibility is achieved by use of LCD that can easily be read at various angles and lighting conditions. Simple and easy to operate switches. Industry first function keys facilitate multi-function operations. Display data in 10 languages to globally support operators around the world.



Comfortable ride with cab damper mounting and Komatsu Bogie (K-Bogie) undercarriage

D375A-6's cab mount uses a cab damper mounting which further improves viscous damper and provides excellent shock and vibration absorption capacity with its long stroke. The cab damper mounting, combined with Komatsu Bogie (K-Bogie) undercarriage, softens shocks and vibrations while traveling over adverse condition that are impossible to absorb with conventional cab mounting methods. The soft spring cab damper isolates the cab from machine body, suppressing vibrations and providing a quiet, comfortable operating environment.

Cab damper mounting

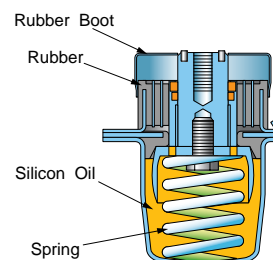

New comfortable air-suspension seat (Optional)

D375A-6 uses a new suspension seat as option. The large sized and thick seat cushion provides excellent support and riding comfort for all operators. In addition, seat heater and ventilation system also provides greater comfortable working environment.



EASY MAINTENANCE

Preventative Maintenance

Preventative maintenance is the only way to ensure long service life from your equipment. That's why Komatsu designed the D375A-6 with conveniently located maintenance points to make necessary inspections and maintenance quick and easy.

LCD monitor with troubleshooting function to prevent critical machine troubles

Various meters, gauges, and warning functions are centrally arranged on the LCD monitor. Offers ease of start-up inspection and promptly warns the operator with a lamp and buzzer if any abnormalities should occur. In addition, countermeasures are indicated in 4 stage codes to ensure safety and prevent the machine from major problems. Replacement times for oil and filters are also indicated.

Maintenance warning screen



Abnormality warning screen



Maintenance List screen for replacement time display

Centralized service station

To ensure convenient maintenance, the transmission and torque converter oil filters are both arranged next to the power train oil level gauge.

Oil pressure checking ports

Pressure checking ports for power train components are centralized to promote quick and simple diagnosis.

Enlarged engine room

Engine room space is enlarged by increasing engine hood height, facilitating maintenance of the engine and related equipment. Solid engine hood prevents dust and rain from entering and keeps the engine clean.

Gull-wing engine side covers

Gull-wing engine side covers facilitate engine maintenance and filter replacement. Side covers are a thick two-piece structure with bolt-on latch to improve durability and repairability.

Easy radiator cleaning with hydraulic drive fan

The radiator can be cleaned by utilization of the reversible, hydraulically driven cooling fan. The fan can be reversed from inside the cab by simply pressing the monitor switch.

Low Maintenance Costs

Track link with wedge ring

D375A-6 track links feature reduced press-fit force and a wedge ring. Conventional track pins are retained only with a large press-fit force. The track link divides pin forces between the wedge ring and press-fit force. This results in easier service with reduced pin damage when turning pins and bushings. The result is improved undercarriage life and reduced maintenance cost through reduced wear, greater pin reusability, and reduced maintenance man-hours.

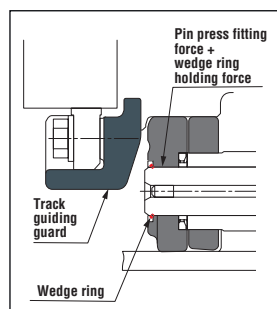

increase mechanical strength, provide longer life, and protect the system from damage.

Flat face O-ring seals

Flat face O-ring seals are used to securely seal all hydraulic hose connections and to prevent oil leakage.

Enclosed hydraulic piping

Hydraulic piping for the blade tilt cylinder is completely housed in the push arm protecting it from damage.

Modular power train design

Power train components are sealed in a modular design that allows the components to be dismantled and mounted without oil spillage, making servicing work clean, smooth, and easy.

Maintenance-free disc brakes

Wet disc brakes require less maintenance.

Highly reliable electric circuit

The electrical circuit reliability is increased by utilizing dust, vibration and corrosion resistant "Sealed connectors". The reinforced electrical wiring harnesses include a circuit breaker and are covered with a heat-resistant material to

NEW SAFETY & MAINTENANCE FEATURES

Komatsu designs our bulldozers with safety in mining operations. Following safety features are optionally available for D375A-6.

Highly mounted headlights

Illuminate the places in front of the machine more effectively. Use of LED lights allows for performing night works more safely.



Rear view camera

Allows the operator to see the rear view image sent from it on the monitor. (Be sure to check the safety around the machine with your eyes. The rear view camera is a mere supplement device to check the rear safety.)



Rear view camera



Camera image

Manual emergency engine shutdown switches *

In case you urgently need to stop the engine, use either of the two switches installed in the cab and at the rear right of the machine. (Do not use the switches for normal engine stop.)



Switch location (at the rear)



Switch location (inside the cab)

Uninterrupted power source *

Uninterrupted power source allows for 2-way radio communication at any time. Interior lights can be turned on with the starting switch at OFF position. (The lights do not work with the opening/closing of the cab door.)

Access lights *

Access lights are installed at two places (the right and left) of the front and at one place of the rear of the machine for safe getting on/off and servicing at night.



Working light for the engine bay *

A working light is installed inside the engine hood (left side) to facilitate night-time inspection and maintenance.



Isolator box *

Battery isolator and starting motor isolator are housed in the isolator box on the left side of the machine to facilitate cut-off of the battery circuit for the maintenance of the machine.

Jump-start connectors are also provided in the box in case the batteries run out.

- A : Starter isolator
- B : Jump start receptacle
- C : Batteries isolator

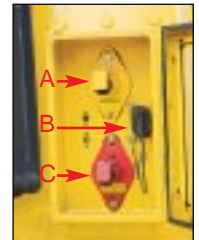

Canister-type breather *

Canister-type breathers are remotely arranged inside the left exterior cover to facilitate check and cleaning of the breather of each component.

- A : Power train case
- B : Flywheel housing
- C : Damper case

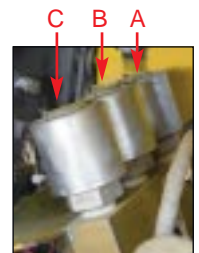

Evacuation service center *

Couplings (made by Wiggins) installed at the rear left of the machine allows for quick drain and charge of oil and coolant. The service center eliminates the need to get on/off the machine and to remove/install covers for the work, and realizes safe and quick servicing.

- A : Engine oil
- B : Radiator coolant
- C : Transmission oil
- D : Hydraulic oil

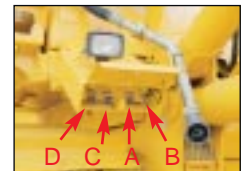

Concentrated sampling points *

Concentrated sampling points are remotely arranged in the right storage for the tool box to facilitate sampling of the oil and coolant from each component.

- A : Engine oil
- B : Radiator coolant
- C : Transmission oil
- D : Hydraulic oil



Provision for platform *

Provision for platform eliminates the need to modify the machine for installation of platform.

Platform with handrails and toe boards

Platform gives access to the side faces and the rear of the machine. Check and refilling of fuel and hydraulic oil, cleaning of cab window glass, check of cab lights, etc. can be performed with ease.

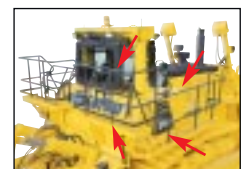

Safety features marked with * are standard equipment for D375A-6 with mining specification.

SPECIFICATIONS



ENGINE

Model Komatsu SAA6D170E-5
 Type 4-cycle, water-cooled, direct injection
 Aspiration Turbocharged, air-to-air aftercooled, cooled EGR
 Number of cylinders 6
 Bore x stroke 170 mm x 170 mm 6.69" x 6.69"
 Piston displacement 23.15 L 1,413 in³
 Governor All-speed and mid-range, electronic
 Horsepower
 SAE J1995 Gross 474 kW 636 HP
 ISO 9249 / SAE J1349* Net 455 kW 610 HP
 Rated rpm 1800 rpm
 Fan drive type Hydraulic
 Lubrication system
 Method Gear pump, force lubrication
 Filter Full-flow
 *Net horsepower at the maximum speed of radiator cooling fan 433 kW 580 HP
 U.S. EPA Tier 3 and EU Stage 3A emissions certified.



TORQFLOW TRANSMISSION

Komatsu TORQFLOW transmission consists of a water-cooled, 3-element, 1-stage, 1-phase torque converter with lockup clutch and a planetary gear, multiple-disc clutch transmission which is hydraulically actuated and force-lubricated for optimum heat dissipation. Gearshift lock lever and neutral safety switch prevent accidental starts.

Gear	Forward		Reverse	
	km/h	mph	km/h	mph
1st	3.5	2.2	4.6	2.9
2nd	6.8	4.2	8.9	5.5
3rd L	8.0	5.0	9.7	6.0
3rd	11.8	7.3	15.8	9.8

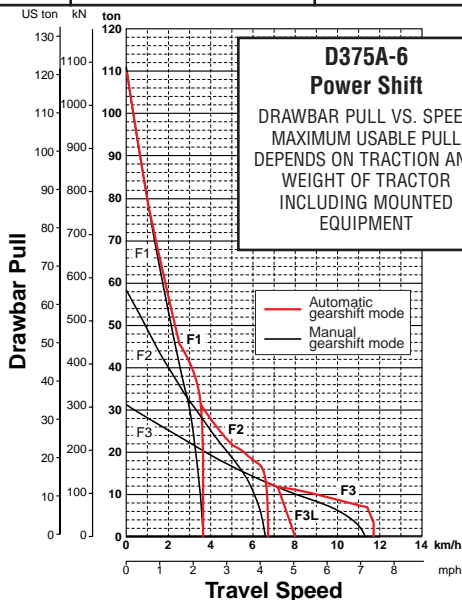

FINAL DRIVES

Double-reduction final drive of spur and planetary gear sets to increase tractive effort and reduce gear tooth stresses for long final drive life. Segmented sprocket teeth are bolt-on for easy replacement.



STEERING SYSTEM

Palm Command Control System (PCCS), joystick controlled, wet multiple-disc steering clutches are spring-loaded and hydraulically released. Wet multiple-disc, pedal/lever controlled steering brakes are spring-actuated hydraulically released and require no adjustment. Steering clutches and brakes are interconnected for easy, responsive steering.

Minimum turning radius 4.2 m 13'9"



UNDERCARRIAGE

Suspension Oscillating equalizer bar and pivot shaft
 Track roller frame Cylindrical, high-tensile-strength steel construction
 Rollers and idlers Lubricated track rollers

Komatsu Bogie (K-Bogie) undercarriage
 Lubricated track rollers are resiliently mounted to the track frame with a bogie suspension system whose oscillating motion is cushioned by rubber pads.

Extreme service track shoes
 Lubricated tracks. Unique seals prevent entry of foreign abrasives into pin to bushing clearances to provide extended service life. Track tension is easily adjusted with grease gun.

Number of shoes (each side) 41
 Grouser height:
 Single grouser 93 mm 3.7"
 Shoe width (standard) 610 mm 24"
 Ground contact area 48560 cm² 7,527 in²
 Ground pressure (tractor) 108 kPa 1.10 kg/cm² 15.6 psi
 Number of track rollers 8
 Number of carrier rollers 2

Extreme service shoes	Additional weight	Ground contact area	Ground pressure*
710 mm 28"	680 kg 1,500 lb	56520 cm ² 8,760 in ²	93.2 kPa 0.95 kg/cm ² 13.5 psi
810 mm 32"	1360 kg 3,000 lb	64480 cm ² 9,990 in ²	83.4 kPa 0.85 kg/cm ² 12.1 psi

*Tractor



COOLANT AND LUBRICANT CAPACITY (REFILL)

Fuel tank 1200 L 317.0 U.S. gal
 Coolant 120 L 31.7 U.S. gal
 Engine 86 L 22.7 U.S. gal
 Torque converter, transmission, bevel gear, and steering system 150 L 39.6 U.S. gal
 Final drive (each side) 65 L 17.1 U.S. gal

D375A-6 CRAWLER DOZER



DIMENSIONS

SEMI-U DOZER WITH GIANT RIPPER

A	2500 mm	8'2"
B	4775 mm	15'8"
C	4265 mm	14'
D	2265 mm	7'5"
E	3980 mm	13'1"
F	10485 mm	34'5"
G	3460 mm	11'4"
H	1485 mm	4'10"
I	1100 mm	3'7"
J	4285 mm	14'1"

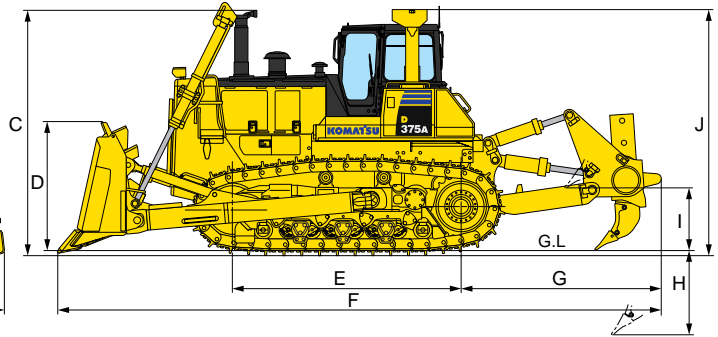
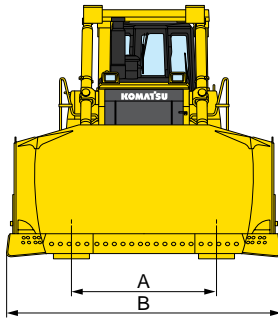

Ground Clearance: 610 mm 2'0"



OPERATING WEIGHT

Tractor weight **53200 kg** 117,290 lb
Including rated capacity of lubricant, coolant, full fuel tank,
operator, and standard equipment.

Operating weight **71640 kg** 157,940 lb
Including Semi-U tilt dozer, giant ripper, cab,
ROPS (ISO 3471), operator, standard equipment, rated capacity
of lubricant, coolant, and full fuel tank.

Ground pressure **145 kPa** 1.48 kg/cm² 21.0 psi



HYDRAULIC SYSTEM

Hydraulic control unit:
Closed-center load sensing system (CLSS) designed for precise and
responsive control, and for efficient simultaneous operation.

Hydraulic control unit:
All spool control valves externally mounted beside the hydraulic tank.
Variable piston pump with capacity (discharge flow) of
366 L/min 96.7 U.S. gal/min for implement at rated engine rpm.
Relief valve setting . . . for implement **27.5 MPa** 280 kg/cm² 3,980 psi

Control valves:
Spool control valve for Semi-U dozer and U dozer.
Positions: Blade lift Raise, hold, lower, and float
Blade tilt Right, hold, and left

Additional control valve required for variable digging angle
multi-shank ripper and giant ripper.
Positions: Ripper lift Raise, hold, and lower
Ripper tilt Increase, hold, and decrease

Hydraulic cylinders Double-acting, piston

	Number of cylinders	Bore
Blade lift	2	140 mm 5.5"
Blade tilt	1	200 mm 7.9"
Ripper lift	2	200 mm 7.9"
Ripper tilt	2	180 mm 7.1"

Hydraulic oil capacity (refill):
Semi-U dozer or U dozer **130 L** 34.4 U.S. gal
Ripper equipment (additional volume):
Giant ripper **45 L** 11.9 U.S. gal
Multi-shank ripper (variable) **45 L** 11.9 U.S. gal



DOZER EQUIPMENT

Blade capacities are based on the ISO 9246.

	Overall length with dozer	Blade capacity	Blade length x height (with spill guard height)	Maximum lift above ground	Maximum drop below ground	Maximum tilt adjustment	Weight		Ground Pressure*
							Dozer equipment	Hydraulic oil	
Semi-U dozer	7780 mm 25'6"	18.5 m ³ 24.2 yd ³	4775 mm x 2265 mm 15'8" x 7'5"	1690 mm 5'7"	735 mm 2'5"	970 mm 3'2"	10920 kg 24,070 lb	45 kg 100 lb	145 kPa 1.48 kg/cm ² 21.0 psi
Strengthened Semi-U dozer	7780 mm 25'6"	18.5 m ³ 24.2 yd ³	4775 mm x 2265 mm 15'8" x 7'5"	1690 mm 5'7"	735 mm 2'5"	970 mm 3'2"	11390 kg 25,110 lb	45 kg 100 lb	145 kPa 1.48 kg/cm ² 21.0 psi
Strengthened U dozer with spill guard	8140 mm 26'8"	22.0 m ³ 28.8 yd ³	5215 mm x 2265 mm (2525 mm) 17'1" x 7'5" (8'3")	1690 mm 5'7"	735 mm 2'5"	1065 mm 3'6"	12420 kg 27,380 lb	45 kg 100 lb	148 kPa 1.51 kg/cm ² 21.4 psi
Semi-U dozer Dual tilt spec.	7780 mm 25'6"	18.5 m ³ 24.2 yd ³	4775 mm x 2265 mm 15'8" x 7'5"	1690 mm 5'7"	735 mm 2'5"	1185 mm 3'11"	11100 kg 24,470 lb	50 kg 110 lb	145 kPa 1.48 kg/cm ² 21.0 psi
Strengthened Semi-U dozer Dual tilt spec.	7780 mm 25'6"	18.5 m ³ 24.2 yd ³	4775 mm x 2265 mm 15'8" x 7'5"	1690 mm 5'7"	735 mm 2'5"	1185 mm 3'11"	11570 kg 25,510 lb	50 kg 110 lb	146 kPa 1.49 kg/cm ² 21.2 psi
Strengthened U dozer with spill guard Dual tilt spec.	8140 mm 26'8"	22.0 m ³ 28.8 yd ³	5215 mm x 2265 mm (2525 mm) 17'1" x 7'5" (8'3")	1690 mm 5'7"	735 mm 2'5"	1300 mm 4'3"	12600 kg 27,780 lb	50 kg 110 lb	148 kPa 1.51 kg/cm ² 21.4 psi

*Ground pressure shows tractor with cab, ROPS (ISO 3471), variable giant ripper, standard equipment and applicable blade.



STANDARD EQUIPMENT

- Alternator, 24 V / 60 A
- Back-up alarm
- Batteries, 2 x 12 V / 170 Ah
- Blower cooling fan
- Color monitor
- Decelerator pedal
- Dry-type air cleaner with dust evacuator and dust indicator
- Eight-roller track frames
- Electrical dust indicator
- Final drive case wear guard
- Hinged front mask
- Hinged underguards with front pull hook
- Horn, warning
- Hydraulics for dozer
- Hydraulic track adjusters
- Lighting system (including four front and two rear lights)
- Lockup torque converter
- Muffler with rain cap
- Palm Command Control System (PCCS) for travel/steering and blade control
- Perforated side covers
- Radiator reserve tank
- ROPS (ISO 3471) brackets
- Segmented sprockets
- Shoes, **610 mm** 24" extreme service, single-grouser
- Starting motors, 2 x 24 V / 7.5 kW
- Suspension seat
- TORQFLOW transmissions
- Track roller guards
- Wet steering clutches



OPTIONAL EQUIPMENT

- Air conditioner with heater and defroster
- Alternator, 24 V / 90 A
- AM/FM radio
- Batteries, 2 x 12 V / 200 Ah
- Counterweight
- Double wiper for cab door
- Dual tilt dozer
- End bits
 - Efficiency type
- Fast fill fuel system
- Fire extinguisher
- High mount head lights
- Hitch
- Hydraulics for ripper
- Inspection light
- KOMTRAX Plus with Orbcomm
- LED lights
- Light for ripper point
- Lunch box holder
- Mirror, rearview
- Panel cover
- Rear view monitoring system
- Seat
 - Air suspension seat
 - Fabric seat
 - Air suspension seat with
 - Large size and thick fabric seat
 - Seat heater
 - Ventilation
- Seat belt
- Shoes:
 - 710 mm** 28"
 - 810 mm** 32"
- Spare parts for first service
- Spill guard for Semi-U dozer
- Starting motors, 2 x 24 V / 11 kW
- Strengthened Semi-U dozer
- Strengthened U dozer with spill guard
- Sun visor
- Tool kit
- Track shoe slip control system
- Vandalism protection kit (cover locks)

ROPS*:

Weight **700 kg** 1,540 lb
 Roof dimensions:
 Width **1980 mm** 6'6"
 Height from
 compartment floor **1872 mm** 6'2"
 *Meets ISO 3471 standards.

Steel cab*:

Weight **570 kg** 1,260 lb
 Dimensions:
 Length **1875 mm** 6'2"
 Width **1740 mm** 5'9"
 Height from compartment
 floor to ceiling **1630 mm** 5'4"
 *Meets ISO 3449 FOPS standard.

Multi-shank ripper:

Hydraulically controlled parallelogram ripper with three shanks. Ripping angle is steplessly adjustable.

Weight (including hydraulic control unit and oil) **6800 kg** 14,990 lb
 Beam length **2910 mm** 9'7"
 Maximum lift above ground . . **1135 mm** 3'9"
 Maximum digging depth . . . **1140 mm** 3'9"

Variable giant ripper:

Variable, parallelogram single-shank ripper ideal for ripping up tough material. Ripping angle is variable. Ripping depth is adjustable in three stages by a hydraulically controlled pin puller.

Weight (including hydraulic control unit and oil) **6200 kg** 13,670 lb
 Beam length **1453 mm** 4'9"
 Maximum lift above ground . . . **1100 mm** 3'7"
 Maximum digging depth **1485 mm** 4'10"

Mining specifications

- Access lights
- Canister-type breather
- Concentrated sampling points
- Evacuation service center
- Group Lube for blade or ripper
- Isolator box
- Manual emergency engine shutdown switches
- Platform with handrails and toe boards
- Provision for platform
- Uninterrupted power source
- Working light for the engine bay

M E M O

A series of horizontal dashed lines for writing.

M E M O

A series of horizontal dashed lines for writing.

KOMATSU[®]